

## Cool67 TopMounted 3D Mounting Instruction v1.0



Date: 04-07-2017

Version: 1.0

LoadLok® International B.V.

Oudewei 4

4004 LS TIEL

Nederland

T +31 (0)344-670 960

F +31 (0)344-722 960

## Document history

Version	Status	Date	Author	Remarks
0.1	Concept	13 Jan 2017		
0.5	Review	04 Apr 2017		
0.6	Review	June 2017		
1.0	Final	04 July 2017	Eelco Noort	

Copyright © 2017 by Loadlok International

All rights reserved. No part of this publication may be reproduced, distributed, or transmitted in any form or by any means, including photocopying, recording, or other electronic or mechanical methods, without the prior written permission or the publisher, except in the case of brief quotations embodied in critical reviews and certain other non-commercial uses permitted by copyright law.

## Contents

1	Introduction .....	4
1.1	Preface .....	4
1.2	Common information .....	4
1.3	Notes to the operator .....	4
1.4	Reading instructions .....	4
1.5	List with abbreviations.....	5
2	Safety.....	6
2.1	Signs on the product.....	6
2.2	Signs in the manual .....	6
3	Mounting the IsoLok track .....	7
3.1	Parts needed .....	7
3.1.1	Mandatory parts.....	7
3.1.2	Optional parts.....	9
3.1.3	Parts to be supplied by yourself.....	10
3.2	Tools needed .....	11
4	Mounting the track.....	12
5	Installation of the Tempwall 40 3D in the vehicle.....	17
6	Check the functionality of Tempwall 40 3D.....	19
6.1	Check the break functionality.....	19
7	Maintenance .....	21
8	Document information.....	22

## 1 INTRODUCTION

### 1.1 PREFACE

This operating manual is an essential aid for the correct and safe use of the insulation partition walls.

This manual contains important information for reliable, proper and efficient use of the insulating partitions. Adherence to the manual helps to avoid dangers, reduce repair costs and downtime and increase the reliability and the lifetime of insulating walls.

The instructions must be available to the operating personnel at all times. Any person who is authorized to use the insulating walls reads the operating instructions before use and then applies them accordingly.

### 1.2 COMMON INFORMATION

Do not expose the Tempwall 40 3D to outside weather conditions, extreme temperatures and direct sunlight.

Any change to the product makes the CE marking invalid. Please contact the manufacturer, if a modification of the product is necessary.

Loadlok reserves the right, if not being met to the requirements, to withdraw the guarantee of their product partially or entirely.

At the end of the lifecycle:

The end user can deliver the multi temp product to Loadlok. Loadlok provides environmentally sound disposal of their product and recycles parts if these are fit for reuse.

### 1.3 NOTES TO THE OPERATOR

This manual is an essential part of the insulating walls. The customer shall ensure that the operator adheres these instructions.

Note that in addition to the instructions, the laws of the country of the place of use are applicable and approved rules for accident prevention alongside with approved technical regulations for safe and professional work shall apply.

Any change to the product makes the CE marking invalid. Please contact the manufacturer, if a modification of the product is necessary.

### 1.4 READING INSTRUCTIONS



WARNING:

This is a warning of a potentially hazardous situation, resulting in moderate or minor injury and / or property damage if the appropriate instruction is not followed exactly.



ATTENTION:

This is a reference to useful information for the safe and effective use.

Orientation

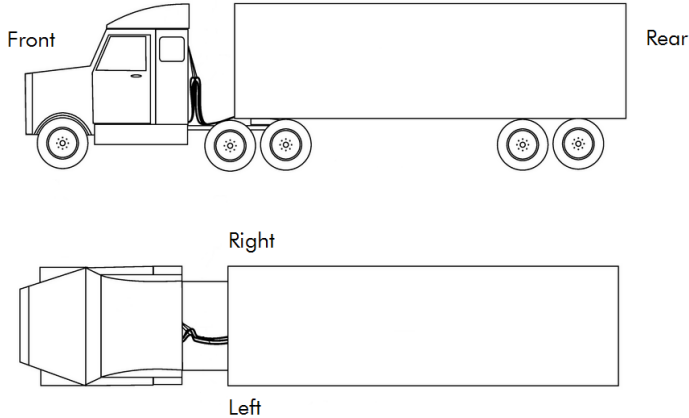





1.5 **LIST WITH ABBREVIATIONS**

3062 J-formed rail with locking holes to guide the Tempwall 40 3D into the trailer.

## 2 SAFETY

### 2.1 SIGNS ON THE PRODUCT

 <p><b>ID. nr: TW60-0203</b></p> <p>MANUFACTURED BY:  DISTRIBUTED BY: </p>	<p>Type designation sign</p> <p>Example of information of the Tempwall 40 3D</p>
 <p>Dient <b>NICHT</b> zur Ladungssicherung! Do <b>NOT</b> use for load securing!</p>	<p>Warning sign</p> <p>Do not use the Tempwall 40 3D as a load securing device!</p>

### 2.2 SIGNS IN THE MANUAL

	<p>WARNING:</p> <p>This is a warning of a risk of danger, with the possible consequence serious injury or death if the designated instruction is not exactly is followed.</p>
---	---

	<p>WARNING:</p> <p>This is a warning of a potentially hazardous situation, resulting in moderate or minor injury and / or property damage if the appropriate instruction is not followed exactly.</p>
---	---

	<p>ATTENTION:</p> <p>This is a reference to useful information for the safe and effective use.</p>
---	--

### 3 MOUNTING THE ISOLOK TRACK

#### 3.1 PARTS NEEDED

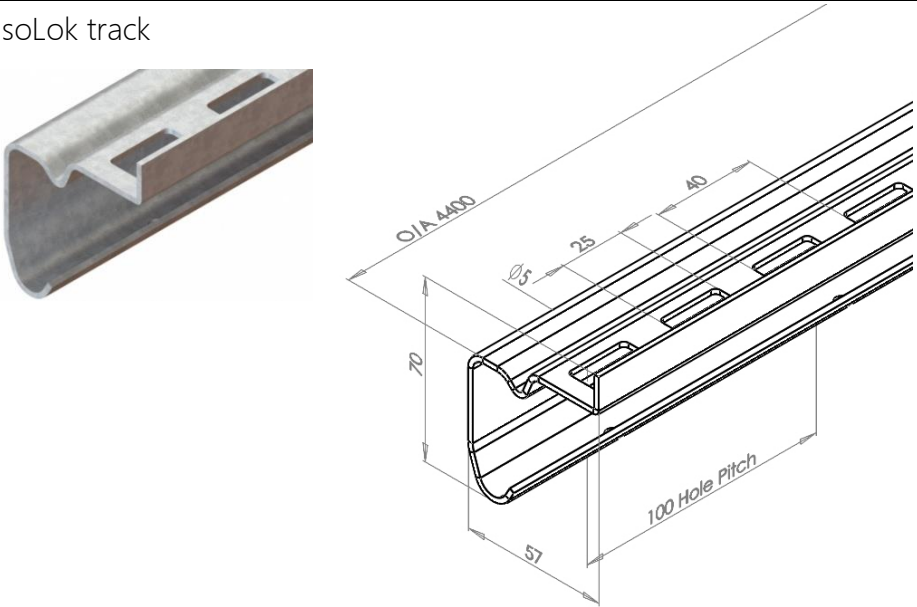

##### 3.1.1 Mandatory parts

Material	Measurements	Article number / Description												
<p>IsoLok track</p> 	<p>Alternative article numbers with descriptions:</p> <table border="0"> <tr> <td>14001345</td> <td>10009470</td> </tr> <tr> <td>3062 PRE GALV 4400 IsoLok track</td> <td>3062 SS304 3200 CS IsoLok track</td> </tr> <tr> <td>14001340</td> <td>14001344</td> </tr> <tr> <td>3062 SS304 4400 IsoLok track</td> <td>3062 SS430 3200 IsoLok track</td> </tr> <tr> <td>14003604</td> <td>14001329</td> </tr> <tr> <td>3062 SS430 4400 IsoLok track</td> <td>3061 PG 3200 IsoLok track</td> </tr> </table> <p>Notes:</p>	14001345	10009470	3062 PRE GALV 4400 IsoLok track	3062 SS304 3200 CS IsoLok track	14001340	14001344	3062 SS304 4400 IsoLok track	3062 SS430 3200 IsoLok track	14003604	14001329	3062 SS430 4400 IsoLok track	3061 PG 3200 IsoLok track	<p>14001332 3062 SS304 3200 IsoLok track</p>
14001345	10009470													
3062 PRE GALV 4400 IsoLok track	3062 SS304 3200 CS IsoLok track													
14001340	14001344													
3062 SS304 4400 IsoLok track	3062 SS430 3200 IsoLok track													
14003604	14001329													
3062 SS430 4400 IsoLok track	3061 PG 3200 IsoLok track													

Material	Measurements	Article number / Description
Rubber end stop 		11060164  Rubber end stop extra hole
Notes: To be fitted on all ends. Is not accompanied with fasteners.		

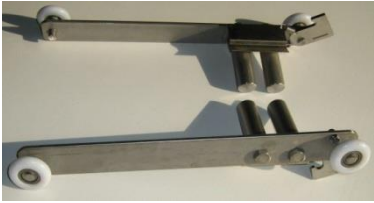

3.1.2 Optional parts

Material	Measurements	Article number / Description
<p>Steel stopper right side</p>  <p>Notes: Is delivered without fasteners</p>		<p>14003348</p> <p>Steel stopper right side for Bulkheads</p>
<p>Steel stopper left side</p>  <p>Notes: Is delivered without fasteners</p>		<p>14003346</p> <p>Steel stopper left side for Bulkheads</p>
<p>Trolley for Tempwall 40 / Isoclear</p>  <p>Notes:</p>		<p>12009535</p> <p>Trolley Tempwall40 2D &amp; Isoclear slide</p>

3.1.3 Parts to be supplied by yourself

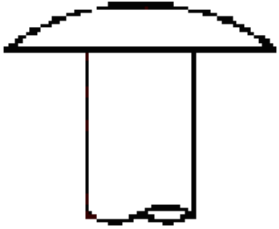
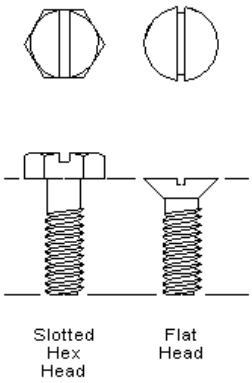
Material	Measurements	Article number / Description
<p>Rivets</p>  <p>Notes: The length of the rivet is subject to the composition of the insulation wall of the trailer.</p> <p>This article is not in the delivery program of LoadLok.</p>	<p>Max 5 mm diameter</p>	<p>N.A.</p>
<p>Screw bolt</p>  <p>Slotted Hex Head      Flat Head</p> <p>Notes: The length of the screw bolt is subject to the composition of the insulation wall of the trailer.</p> <p>Flathead optional: holes counter sunk for flush mounting. If this is a preference for mounting the IsoLok track, the mounting holes can be made counter sunk.</p> <p>This article is not in the delivery program of LoadLok.</p>	<p>Max 5 mm diameter</p>	<p>N.A.</p>

### 3.2 TOOLS NEEDED

Blind rivet pliers



Wrench



Spirit level tool



Measuring tape



Pipe wrench



## 4 MOUNTING THE TRACK



ATTENTION:

The procedure as described here must be performed twice, once on the left hand side and once on the right hand side of the trailer.

1. Measure the effective length of track to be used.

- 2.

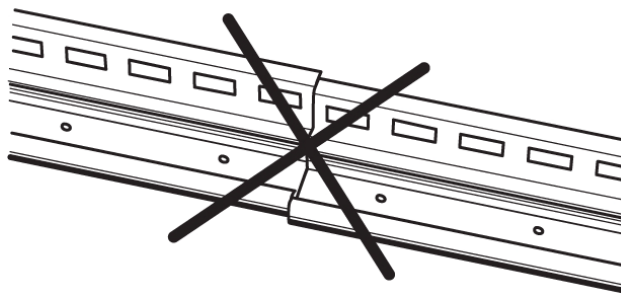
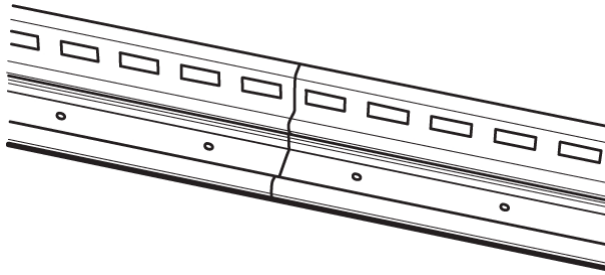

For smooth running of the balancer trolley wheels over several tracks LoadLok advises to weld the tracks in the joining point in such way the balancer or trolley wheels never can interfere with the weld.

Make sure that the end edges of the rails are straight, so that the wheels of the vehicle can run continuous smoothly.

3. If the IsoLok track is to be shortened, please leave enough material length in order to fasten the rubber end-stop with its steel cover plate.



ATTENTION:

Loadlok advises to use adhesive between the IsoLok track and side walls which is fit for this purpose.

4.

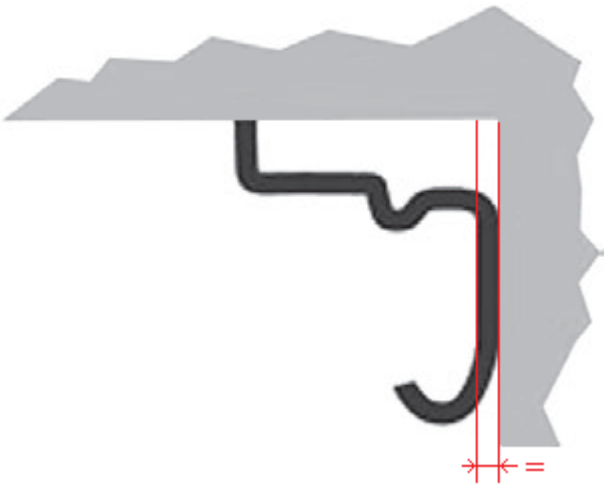

Insert the guide rails in the outer left or right side of your vehicle.

Install the rails vertical (both to the wall and also to the ceiling).

5.

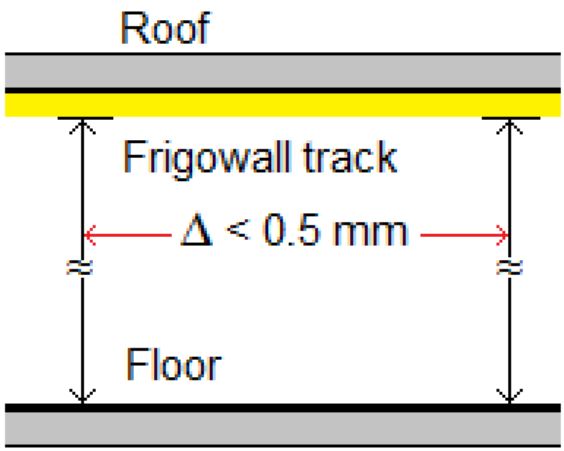

Side view

Measure the distance from the floor to the IsoLok track on both ends of the track.

The difference must be less than 0.5 mm as is shown in the illustration.

6.

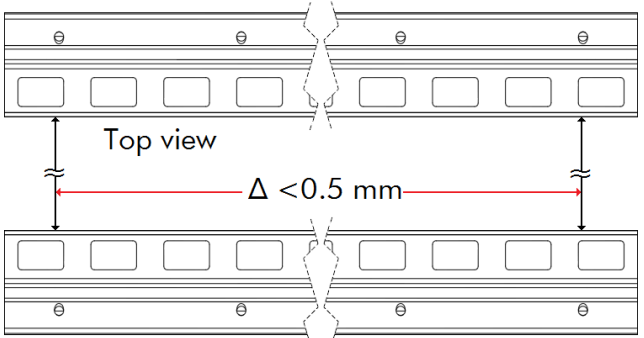

Top view

Measure the distance between the tracks in the vehicle, as shown in the illustration.

The difference must be less than 0.5 mm.

7.

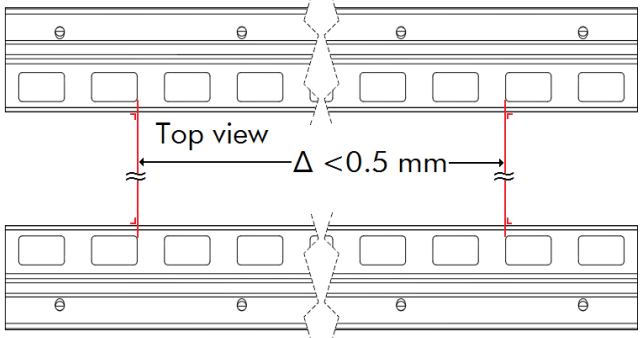

Top view

The locking holes must be parallel.

The difference must be less than 0.5 mm.



ATTENTION:

Maintain the IsoLok track on level!

The tolerance for smooth running is  $< 0.5$  mm!

8. Use all mounting holes with a rivet or a screw bolt.



ATTENTION:

When using rivets:

Please fasten the IsoLok track to a minimum length of 750 mm with bolts for maintenance purposes of the Cool67 TopMounted 3D.

These sections must be opposite to each other!



ATTENTION:

Wait until the adhesive is fully hardened. Only then proceed with rolling the Frigowall assembly into the track.

9. In the case the trailer is reinforced in the edges with corner profiles:

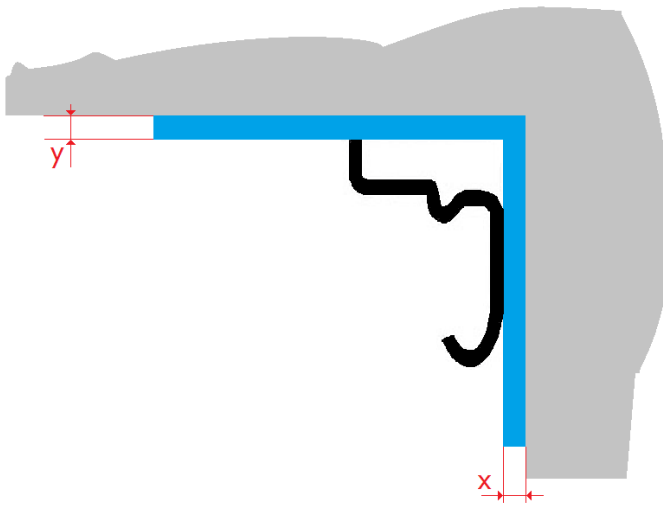

The corner profile is shown in blue colour.

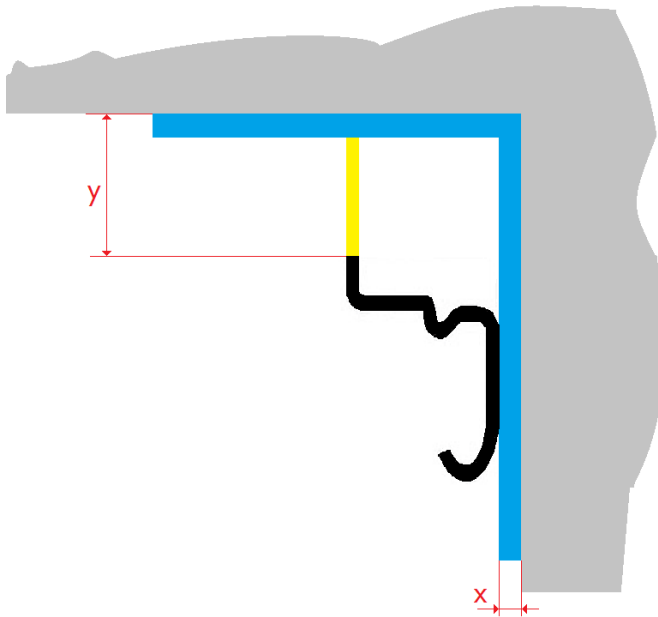

LoadLok advises to fill the gap between the roof and the IsoLok track. (shown in the illustration in yellow)



ATTENTION:

The X and Y values are vital when ordering



ATTENTION:

Note that the locking holes must remain free of obstacles

10. Mount the end stops at the bulkhead side of the track. (As is shown on position 11 or 12)

11.

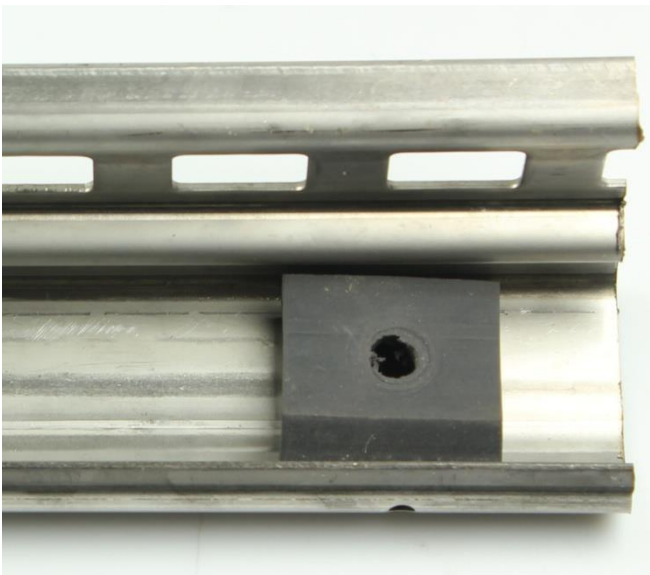

Use the drain hole to mount / attach the end stop.

LoadLok advises to use a M5 x 30 bolt.

12.

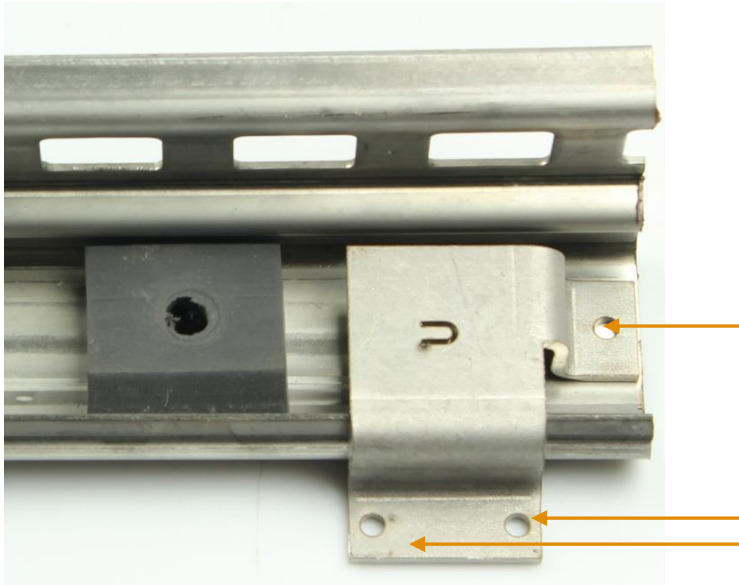

Optional mount the steel stopper as shown in the figure. The hole in the IsoLok track must be drilled.

In total 3 holes must be drilled!



## 5 INSTALLATION OF THE TEMPWALL 40 3D IN THE VEHICLE



WARNING:

Ensure that the vehicle is positioned on a horizontal plane before continuing with the installation!



WARNING:

Severe injuries are possible due to the falling wall.

1. Mount the wall with the trolleys into the track by hand.
2. Carefully lift the Tempwall 40 3D against the opening of the mounted guide rails and insert the wheels of the trolleys into the rail.
3. Slide the Tempwall 40 3D as far into the vehicle as possible so that the Tempwall 40 3D can not roll out of the unsecured rails.

4.



Override the brake by pulling on the brake straps on both sides.

5. Push the Tempwall 40 3D at least so far in the trailer that the locking finger is in a breakhole



WARNING:

Severe injuries are possible due to a falling wall.



ATTENTION:

The wheels are freely movable sideways up to 10mm to compensate for differences in vehicle width.

6. Mount the end stops at the bulkhead side of the track. (As is shown on position 7 or 8)

7.



Use the drain hole to mount / attach the end stop.

LoadLok advises to use a M5 x 30 bolt.

8.

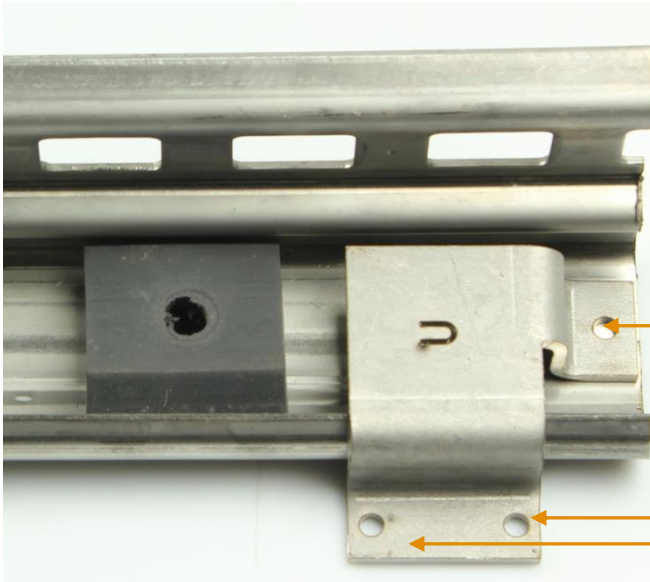

Optional mount the steel stopper as shown in the figure. The hole in the IsoLok track must be drilled.

In total 3 holes must be drilled!

9.



ATTENTION:

Perform step 6 also for the other side of the trailer!

## 6 CHECK THE FUNCTIONALITY OF TEMPWALL 40 3D

### 6.1 CHECK THE BREAK FUNCTIONALITY

1. Lift the Tempwall 40 3D into such an angle that it is in the area which is colored red.

2.  The break locks must be positioned in the middle of the breaking hole (as shown in red).



Correct position of the brake in the IsoLok track

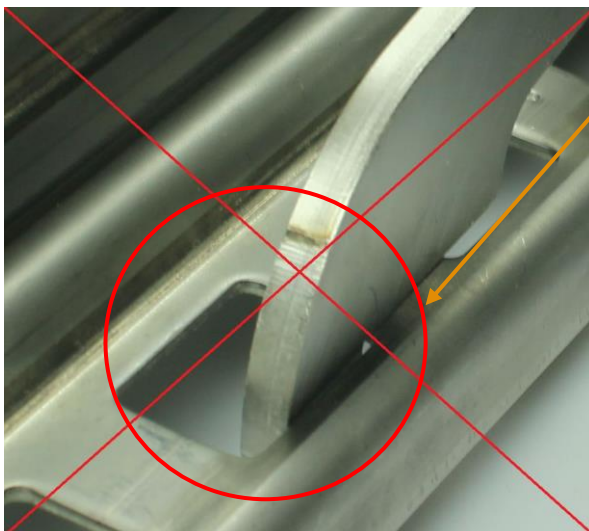

Incorrect position of the brake in the IsoLok track

3. If this is not the case bend the break lock until it does!

4.



WARNING:  
Check both sides!



WARNING:  
If the functionality of the breaking locks cannot be assured:

- Contact Loadlok immediately!
- Do not deliver vehicle to the public road!

## 7 MAINTENANCE

Maintenance table			
Manifestation of the failure	Possible cause or procedure to detect the failure	Solution	Performed by (unskilled till certified)
The brakefingers are not locking in the center of the braking hole		Adjust the brakefingers according paragraph "Check the brake functionality"	Mechanic

If the Frigowall is inspected on a regular basis on above mentioned inspection points the product lasts a lifetime.

## 8 DOCUMENT INFORMATION

Principal	Contractor	Digital file name
LoadLok International	Foxiz BV	Cool67 TopMounted 3D Mounting Instruction v1.0 July 2017

Remarks, corrections or suggestions are welcomed by the technical department.